

Name _____

u

Short Vowel

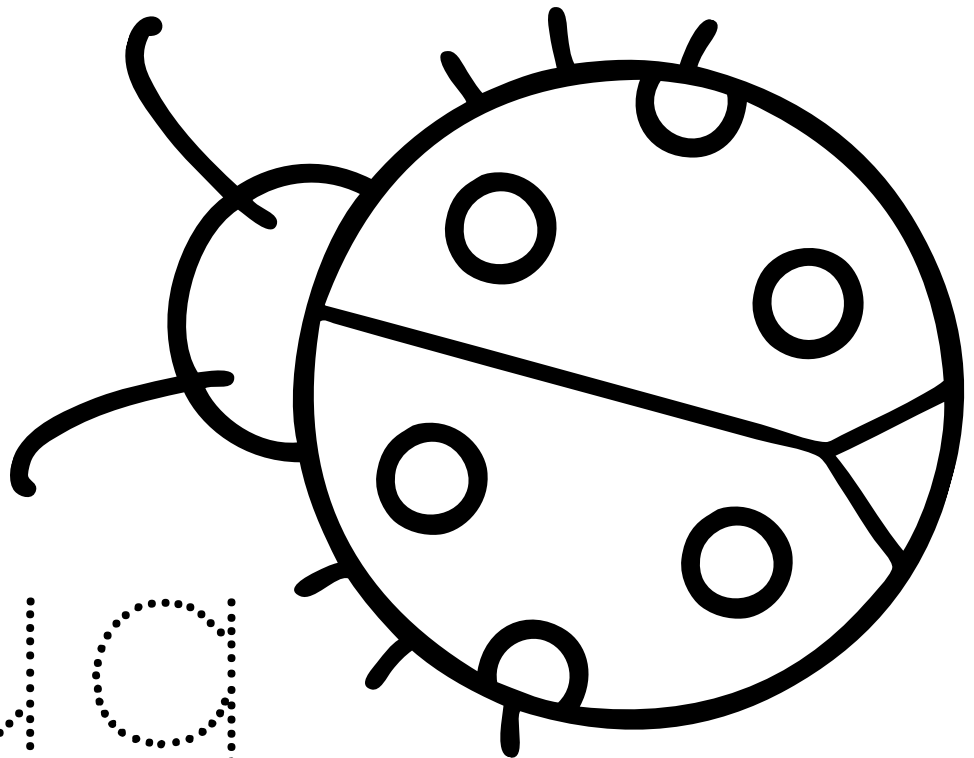

bug

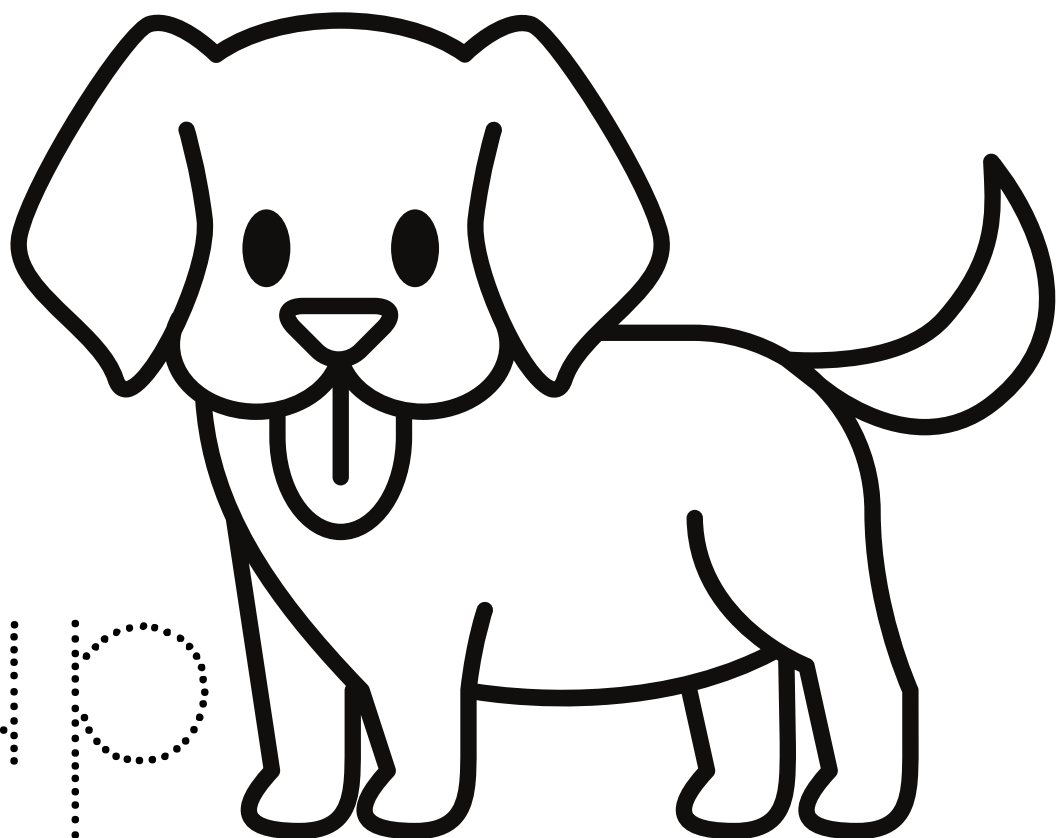

pup

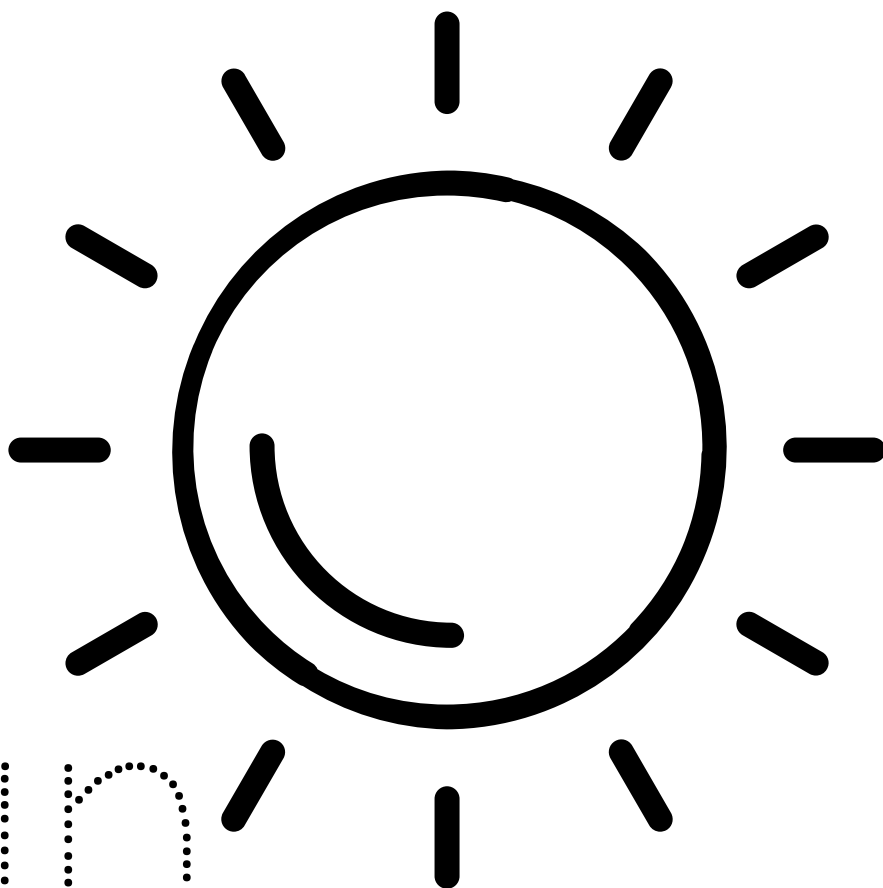

sun

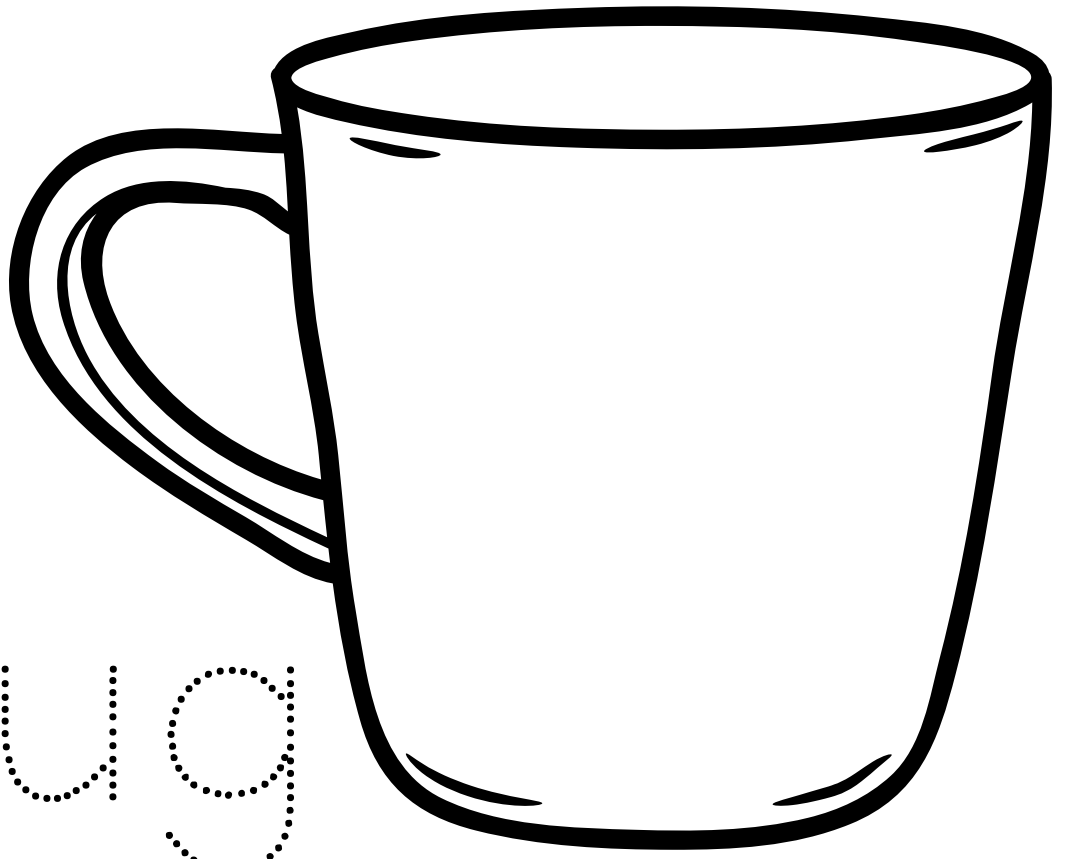

mug

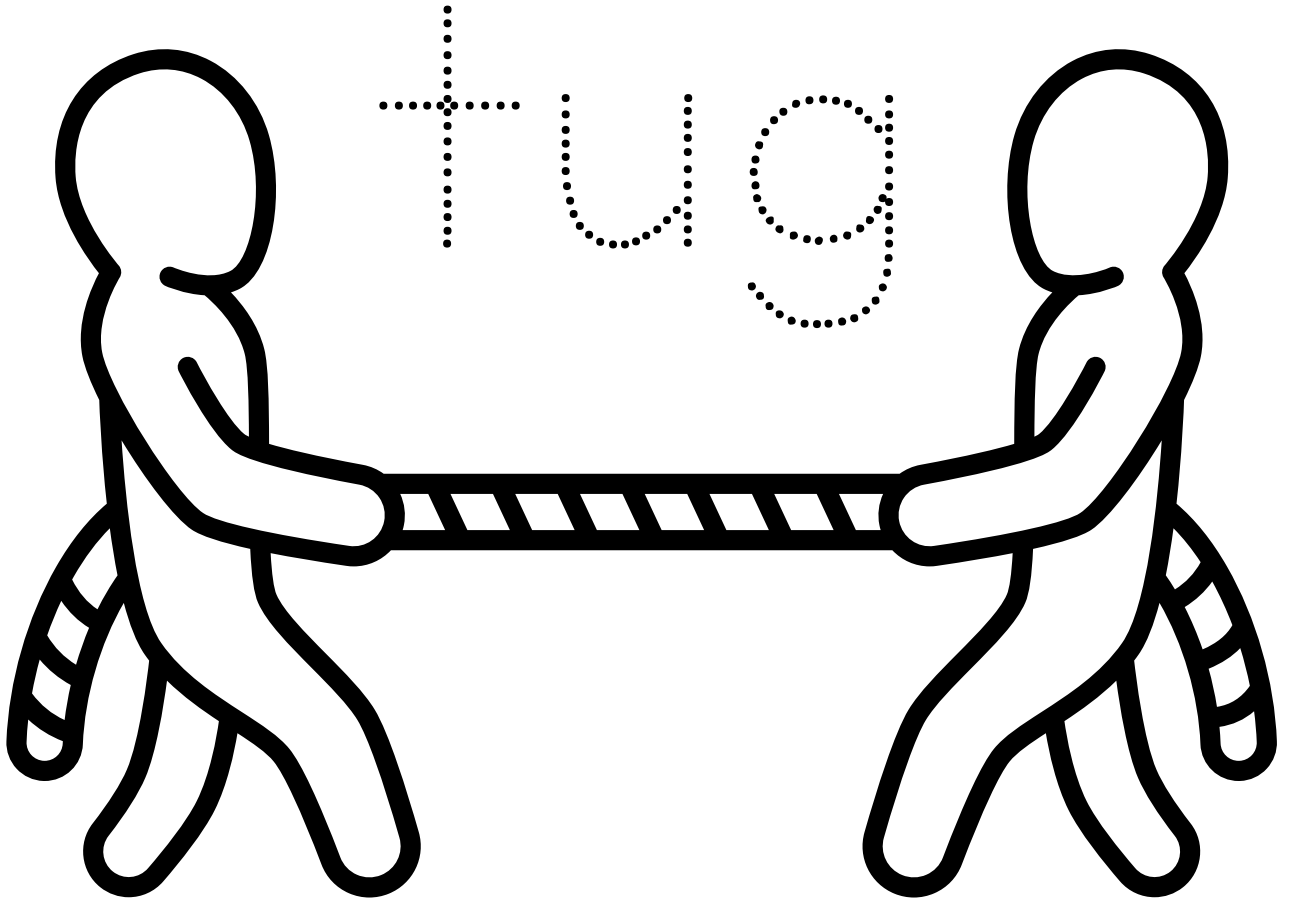

tug

rug

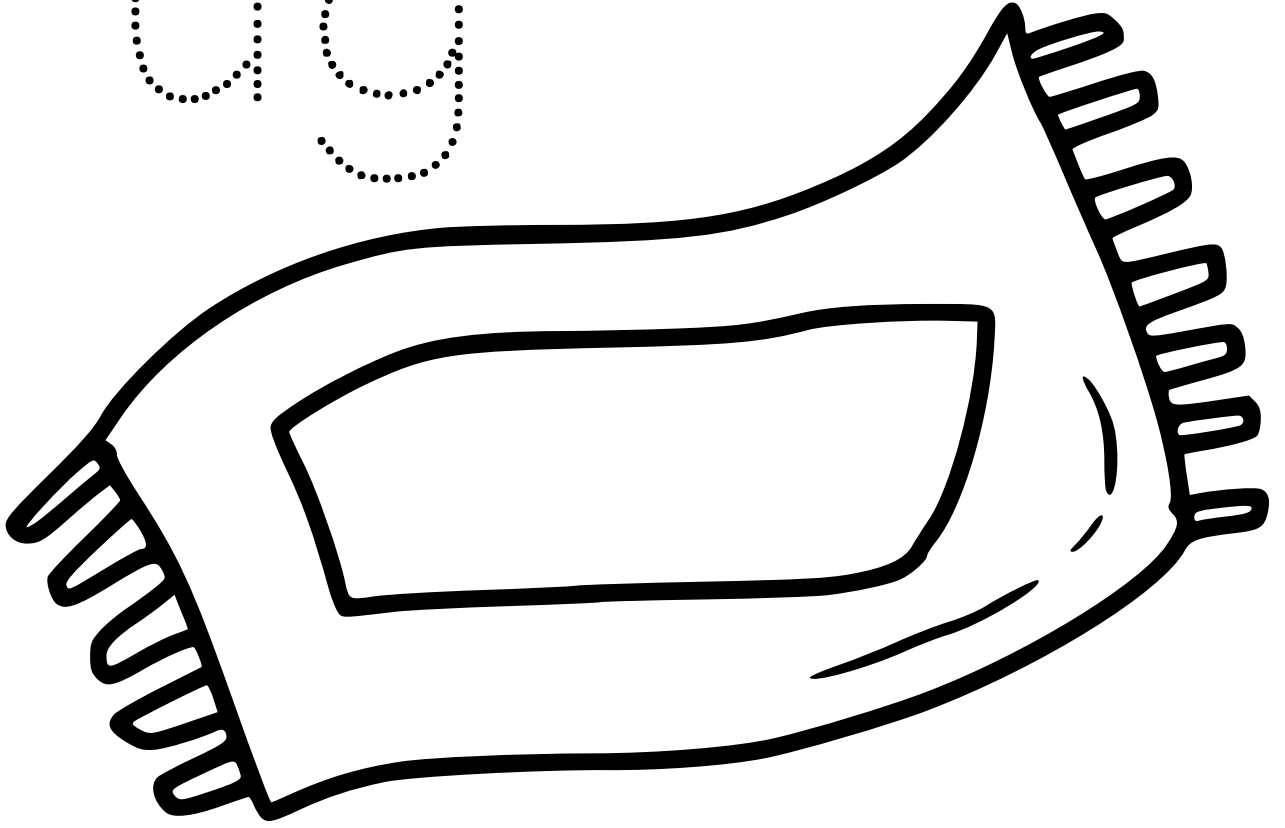

bun

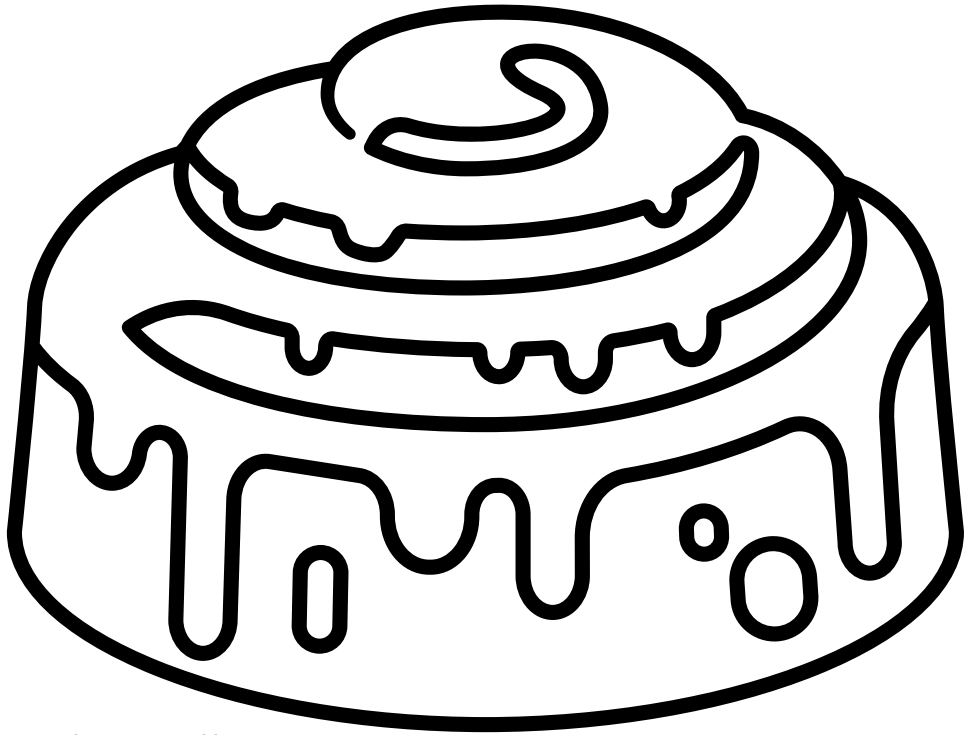

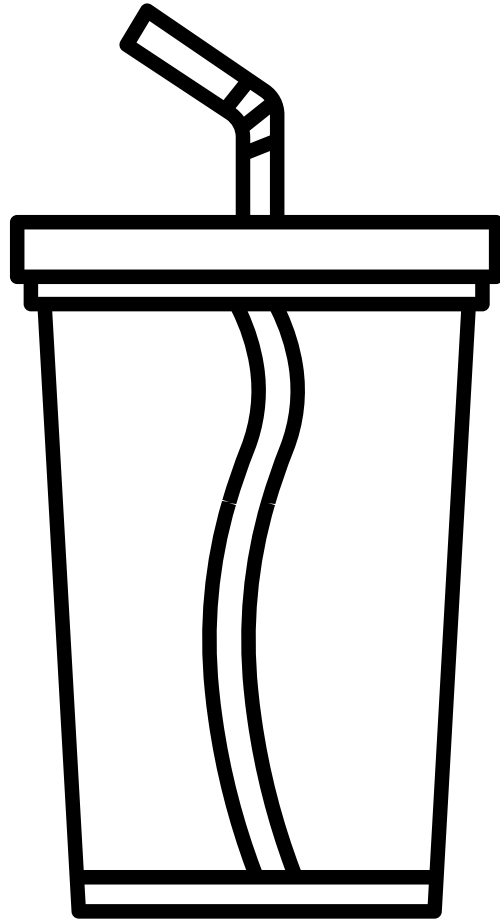

cup

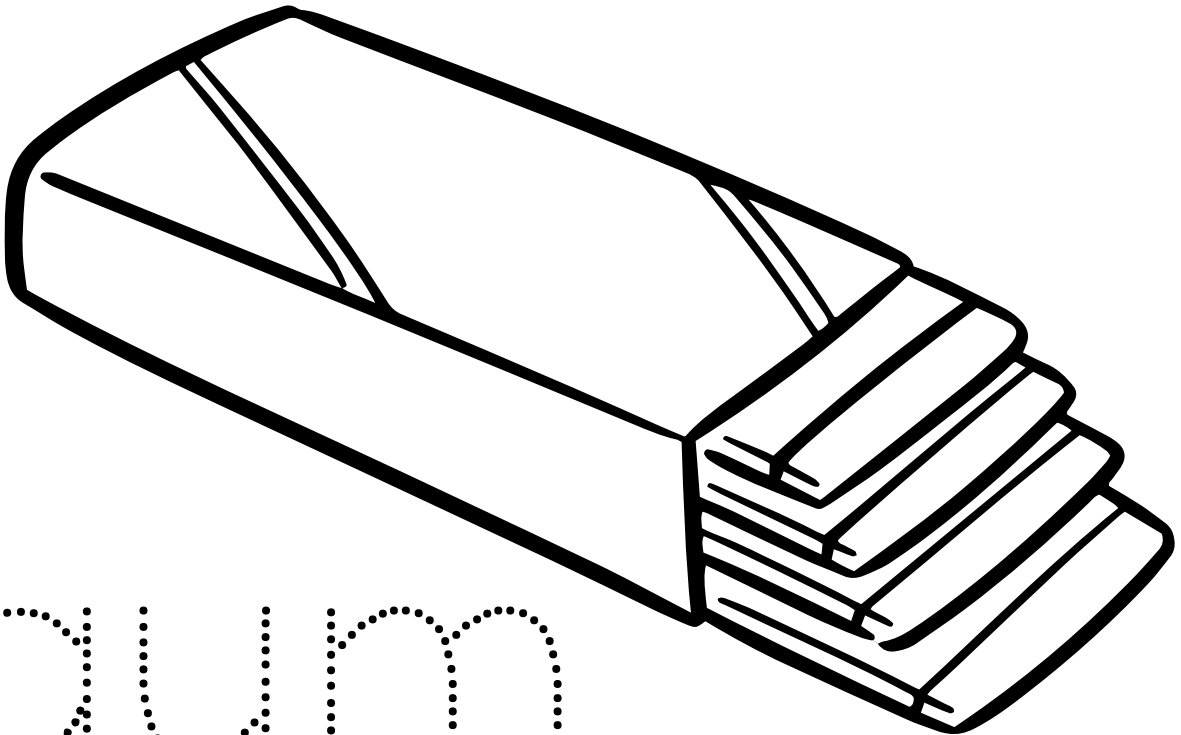

gum

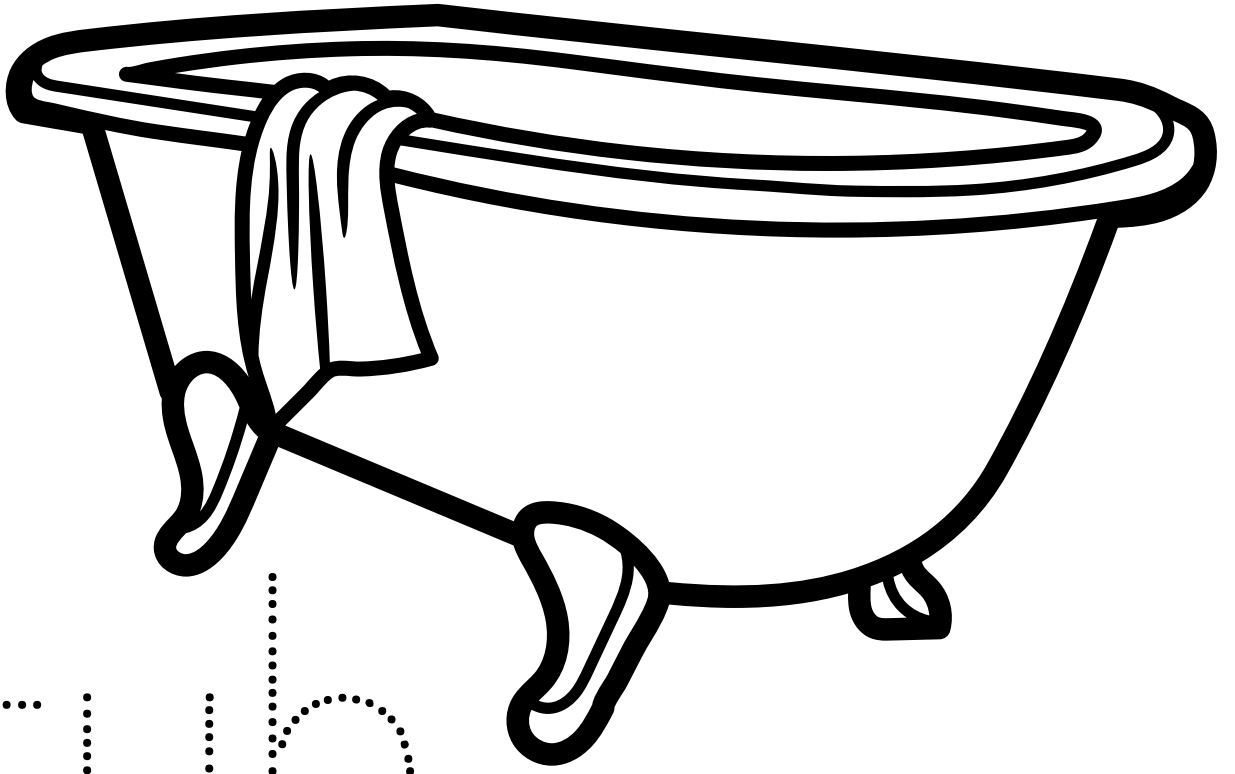

tub

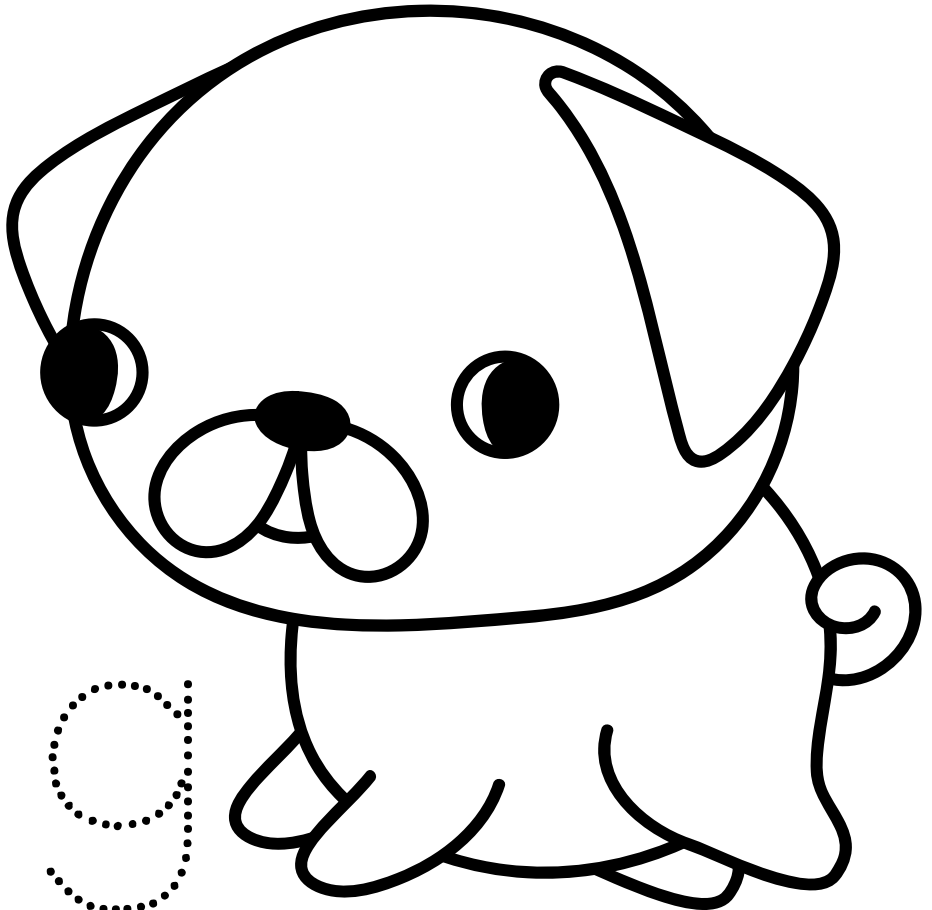

pug

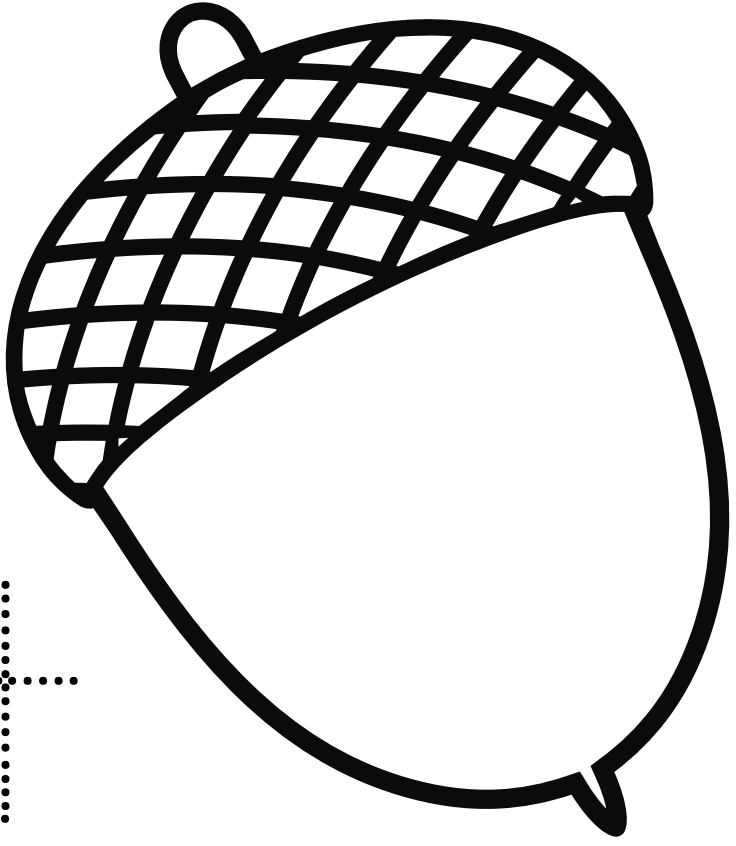

nut

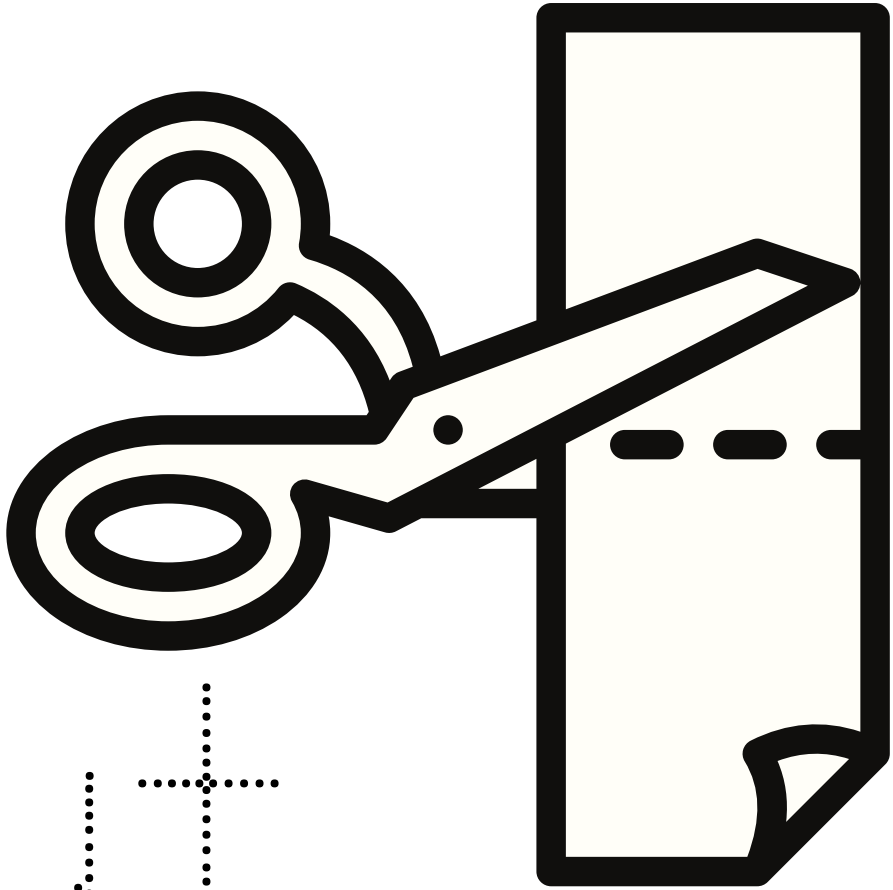

cut